

Dräger X-am[®] 1100, 1700, 2000 approved as type LQG 00xx

Multi-Gas Monitor Technical Manual



Content

For Your Safety	4
Safety symbols used in these Technical Manual	4
Intended Use	5
Tests and Approvals	6
Marking	6
Intended Operating Area and Operating Conditions	7
What is What	8
Front panel	8
Rear panel	8
Display	8
Special Symbols	9
Configuration	10
Standard Gas Configuration	10
Standard Device Configuration on Delivery	10
Activating the Device	11
Operation	12
Switching on the device	12
Switching off the device	12
Before entering the workplace	13
During operation	13
Calling the Info Mode	14
Calling the Quick Menu	15
Possible functions of the quick menu	15
Calling the Calibration Menu	16
Calibration menu functions	17
Identifying Alarms	18
Concentration pre-alarm A1	18
Concentration main alarm A2	18
STEL / TWA exposure alarm	18
Battery pre-alarm	19
Battery main alarm	19
Device alarm	19
End of operation	19
Pump Operation	20
With Dräger X-am 125 pump	20
With hand pump adapter and rubber ball pump	20
Observe the following during pump operation mode	20
Configuring the Device	21
Read Data Base and Display Graphically	22

Faults, Cause and Remedy	23
Warning messages	23
Fault messages	25
Maintenance	28
Maintenance intervals	28
Carrying Out the Function Test with Gas (Bump Test)	29
Manual implementation without the documentation of result in the device memory	29
Menu implementation with the documen-tation of results in the device memory ..	30
Automatic implementation with the Bump Test Station	33
Calibrating / Adjusting the Device	35
Carrying out the fresh air calibration	36
Carry out the 1-button calibration	38
Calibrating/adjusting the sensitivity for a single measuring channel	40
Replacing the Batteries / Rechargeable Batteries	42
Charging the Rechargeable Batteries	43
Charging with the multiple charging station	43
Charging with charging module and plug-in power pack or vehicle charging adapter	45
Replacing the Sensors	46
Care	48
Disposing of the Device	49
Technical Data	50
Sensor Data	50
Order List	52
Accessories	53
Spare parts	54
Declaration of Conformity	55

For Your Safety

Strictly follow the Instructions for Use

Any use of the device requires full understanding and strict observation of the Instructions for Use supplied with the device.

The device is only to be used for the purposes specified here.

Maintenance

The maintenance intervals and measures stated in this Technical Handbook as well as the specifications in the Instructions for Use of the used DrägerSensors¹⁾ must be observed.

Repair of the instrument may only be carried out by trained service personnel.

Accessories

Do not use accessory parts other than those listed in the order list.

Safe coupling with electrical devices

Devices which are not mentioned in the Instruction for Use or in this Technical Handbook can only be coupled electronically after consultation with the manufacturers or an expert.

Use in areas subject to explosion hazards

Devices or components for use in explosion-hazard areas which have been tested and approved according to national, European or international Explosion Protection Regulations may be used only under the conditions explicitly specified in the approval and with consideration of the relevant legal regulations. The equipment or components may not be modified in any manner. The use of faulty or incomplete parts is forbidden. The appropriate regulations must be observed at all times when carrying out repairs on these devices or components.

Safety symbols used in these Technical Manual

These Technical Manual contain a number of warnings for risks and hazards which might occur when using the device. These warnings contain signal words to alert you to the degree of hazard you may encounter. These signal words and corresponding hazards are as follows:

DANGER

Indicates an immediate hazardous situation which, if not avoided, could result in death or serious injury.

WARNING

Indicates a potential hazardous situation which, if not avoided, could result in death or serious injury.

¹⁾ The Instructions for Use of the DrägerSensors are supplied with the device on CD.

▲ CAUTION
Indicates a potential hazardous situation which, if not avoided, could result in injury or damage to property. Can also be used to warn against any wanton actions.

NOTICE
Additional information on the use of the device.

Intended Use

Portable gas measuring device for the continuous monitoring of the concentration of several gases in the ambient air in the working area and in explosion-hazard areas.

X-am 1100, X-am 1700:

independent measurement of four gases.

X-am 1100: 120 days service life from activation of the device (refer to page 11).

X-am 1700: 2 years service life from activation of the device (refer to page 11).

X-am 2000 depending on the device type:

independent measurement of one gas up to four gases.

Tests and Approvals

Marking



Power pack 83 18 703;
approved as type ABT 0000
Temperature class T4
 $-20^{\circ}\text{C} \leq T_a \leq +50^{\circ}\text{C}$
use with alkaline batteries
Energizer No. E91
Energizer No. EN91 (industrial)
Varta Type 4106 (power one)

Temperature class T3
 $-20^{\circ}\text{C} \leq T_a \leq +40^{\circ}\text{C}$
use with NiMH batteries
GP 180AAHC (1800 mAh)

Power pack 83 18 704;
approved as HBT 0000
Temperature class T4
 $-20^{\circ}\text{C} \leq T_a \leq +50^{\circ}\text{C}$

Serial no. ¹⁾

WARNING

Read the safety measures in the Instructions for Use.
Do not replace or charge batteries in potentially explosive areas. Danger of explosion!

¹⁾ Year of construction is coded by the third capital letter of the serial number: T = 2003, U = 2004, W = 2005, X = 2006, Y = 2007, Z = 2008, A = 2009, B = 2010, C = 2011, etc.
Example: Serial number ARUH-0054: the third letter is U, so the year of construction is 2004.

Intended Operating Area and Operating Conditions

Hazardous areas classified by zones

The device is intended to be used in hazardous areas or mines susceptible to firedamp classified zone 1 or zone 2, within a temperature range of $-20\text{ }^{\circ}\text{C}$ to $+50\text{ }^{\circ}\text{C}$ or $-20\text{ }^{\circ}\text{C}$ to $+50\text{ }^{\circ}\text{C}$ (depending on battery pack and batteries), where gases of explosion groups IIA, IIB or IIC and temperature class T3 or T4 (depending on battery pack and batteries) may be present. If used in mines, the device is only to be used in areas known to have a low risk of mechanical impact.

Hazardous areas classified by divisions

The device is intended to be used in hazardous areas or mines susceptible to firedamp classified Class I&II, Div. 1 or Div. 2, within a temperature range of $-20\text{ }^{\circ}\text{C}$ to $+50\text{ }^{\circ}\text{C}$ or $-20\text{ }^{\circ}\text{C}$ to $+50\text{ }^{\circ}\text{C}$ (depending on battery pack and batteries), where gases or dusts of groups A, B, C, D or E, F, G and temperature class T3 or T4 (depending on battery pack and batteries) may be present.

Safety Instructions

WARNING

To reduce the danger of explosion, do not mix new batteries with old batteries and do not mix batteries made by different manufacturers.

WARNING

Always disconnect the device from the power pack before carrying out any maintenance operations.

WARNING

Substitution of components may impair intrinsic safety.

CAUTION

Not tested in an oxygen-enriched atmosphere ($>21\text{ } \% \text{ O}_2$).

Only the combustible gas detection portion of this instrument has been assessed for performance.

WARNING

High off-scale readings may indicate an explosive concentration.

WARNING

Before each day's usage sensitivity must be tested on a known concentration of the gas to be detected equivalent to 25 to 50% of full scale concentration. Accuracy must be within 0 to +20% of the actual value. Accuracy may be corrected by calibration.

What is What

Front panel

- 1 Gas entry
- 2 Alarm LED
- 3 Buzzer
- 4 OK key
- 5 + key
- 6 Display

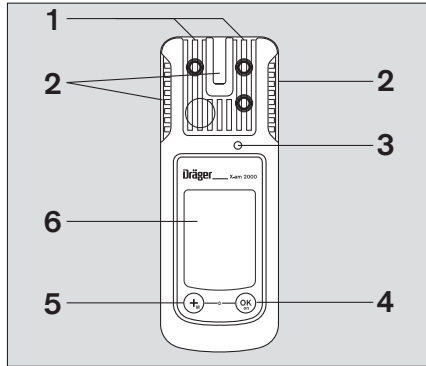

Rear panel

- 1 IR interface
- 2 Fastening clip
- 3 Type plate
- 4 Charging contacts
- 5 Power pack

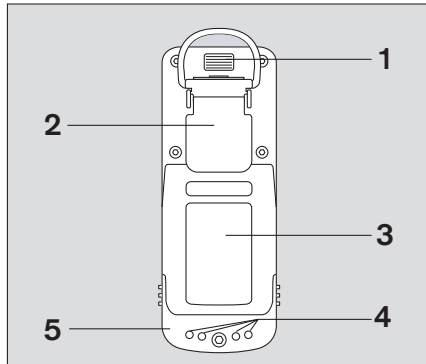





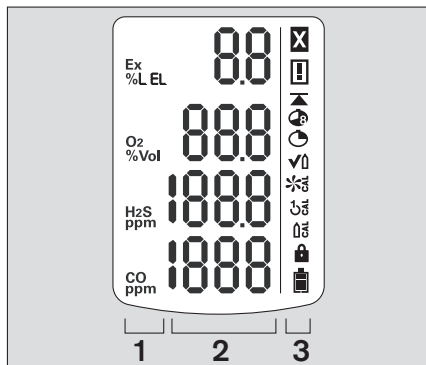









Display

- 1 Measured gas display
- 2 Measured value display
- 3 Special symbols



Special Symbols

-  Fault message, refer to page 14
-  Warning message, refer to page 14
-  The peak value display for all measuring gases, refer to page 14
-  The exposure evaluation display (TWA) for measuring gas H₂S and CO, refer to page 14
-  The exposure evaluation display (STEL) is switched on for measuring ranges H₂S and CO, refer to page 14
-  The device is set to function test with gas (bump test), refer to page 29
-  The device is set to the fresh air calibration function, refer to page 36
-  The device is set to the 1-button calibration function, refer to page 38
-  The device is set to the single-gas calibration function, refer to page 40
-  The function for password entry is active, refer to page 16
-  Battery / rechargeable battery 100 % full
-  Battery / rechargeable battery 2/3 full
-  Battery / rechargeable battery 1/3 full
-  Battery / rechargeable battery empty

Configuration

Standard Gas Configuration

DrägerSensor	CatEx 125 PR [%LEL]	XXS O ₂ [Vol.-%]	XXS CO [ppm]	XXS H ₂ S LC [ppm]
Measuring range ²⁾	0 to 100	0 to 25	0 to 2000	0 to 100
Alarm A1 ²⁾				
- setpoint	20	19 ¹⁾	30	10
- can be acknowledged	yes	no	yes	yes
- self-latching	no	yes	no	no
Alarm A2 ²⁾				
- setpoint	40	23	60	20
- can be acknowledged	no	no	no	no
- self-latching	yes	yes	yes	yes

Standard Device Configuration on Delivery

X-am 1100 / X-am 1700 / X-am 2000	
Function test with gas (bump test) in Quick Menu ²⁾	off
Fresh air calibration in Quick Menu ²⁾	off
Life sign ²⁾	on
Switch off ²⁾	allowed
LEL factor ²⁾ (CH ₄)	4.4 (4.4 vol. % corresponds to 100 %LEL)
Averaging time ²⁾	15 minutes for STEL 8 hours for TWA

Changing the standard configuration: See "Configuring the Device" on page 21.

WARNING

After a basic initialization has been carried out with the PC software Dräger CC Vision, individual alarm settings may have been changed.

¹⁾ In the case of O₂ A1 is the lower alarm setpoint: an alarm is issued if the value is too low.

²⁾ Different settings can be selected to meet customer requirements on delivery. The current setting can be checked and changed with the software "CC Vision".
A version of Dräger CC-Vision which can be used for Dräger X-am 1100/1700/2000 is supplied with the device on CD.

Activating the Device

Before using the device for the first time, insert the supplied batteries or a charged NiMH power pack T4 (order no. 83 18 704), refer to Replacing the Batteries, page 42. Charge the rechargeable batteries if necessary, page 43.

The Dräger X-am 2000 is ready for operation.

Only in the case of Dräger X-am 1100 and Dräger X-am 1700:



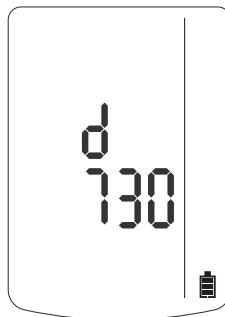

The following activation sequence also has to be carried out:

- Press and hold the \oplus key for approx. 3 seconds until the countdown » 3 . 2 . 1 « shown in the display has elapsed.
- The remaining operating time is displayed, e.g. » d 730 « (remaining operating time 730 days).
- After that, the device is automatically switched off again. You can switch it on again at any time by pressing the OK key.





Operation

Switching on the device

- Press and hold the  key for approx. 3 seconds until the countdown » **3 . 2 . 1** « shown in the display has elapsed.
 - All the display segments, including the visual, audible and vibration alarms, are activated for a short time.
 - The software version is displayed.
 - The device performs a self test.
 - The remaining operating time is displayed, e.g. » **d 730** « (remaining operating time 730 days). This applies to Dräger X-am 1100 / 1700 and if the service life is activated in Dräger X-am 2000.
 - All alarm setpoints A1 and A2 as well as »  « (TWA)¹⁾ and »  « (STEL)^{*)} for H₂S and CO are displayed in succession.
 - The time until the calibration interval expires is displayed in days, e.g. » **CAL 73** «.
 - The sensor which is next due for calibration/adjustment is displayed with the days remaining until the next calibration/adjustment e.g. » **Ex %UEG CAL 20** «.
 - During the warm-up time of the sensors, the respective display of the measured value flashes and the special symbol »  « (for warning) is displayed. No alarms are issued during the running-in period of the sensors.
- Press the  key to cancel the display of the activation sequence.

Switching off the device





- Press and hold the  key and the  key at the same time until the countdown » **3 . 2 . 1** « shown in the display has elapsed.
 - Before the device is switched off, the visual, audible and vibration alarms are activated for a short time.

¹⁾ Nur wenn in Gerätekonfiguration aktiviert. Auslieferungszustand: nicht aktiviert.

Before entering the workplace

⚠ CAUTION

Check and, if necessary, adjust the calibration before carrying out safety-relevant measurements. A function test with gas (bump test) must be carried out in accordance with local regulations.

- Switch on the device. The current measured values are shown in the display.
- Observe any warning »  « or fault »  « messages.
 -  The device can be operated normally. If the warning message does not go out automatically during operation, the device must be maintained after the end of use.
 -  The device is not ready to measure and requires maintenance.
If one of these special symbols is displayed, appropriate measures, refer to page 23 to page 25, must be taken.
- Check that the gas inlet opening on the device is not covered.

⚠ WARNING

The presence of catalyst poisons in the measured gas (e.g., volatile silicone, sulfur, heavy metal compounds or halogenated hydrocarbons) can damage the DrägerSensor CatEx 125 PR. If the sensor cannot be calibrated to the target concentration anymore, the sensor must be replaced. The display of the CatEx 125 PR sensor may be incorrect in an oxygen-poor atmosphere. Electrical operating safety (Ex protection) is not guaranteed in an oxygen-enriched atmosphere. Danger of explosion!

During operation

During operation, the measured values for every measured gas are displayed.

If a measuring range is exceeded or a negative drift occurs, the following displays are shown instead of the measured value display:

»  « (too high concentration) or »  « (negative drift).

- If the concentrations of combustible materials are too high, this may result in a lack of oxygen.
- If the O₂ concentrations are under 8 vol. %, a fault with »  « is displayed for the Ex channel instead of the measured value, if the measurement is below the pre-alarm threshold.

In the event of an alarm, the corresponding displays, including the visual, audible and vibration alarms are activated – refer to “Identifying Alarms” on page 18.

⚠ WARNING

When the measuring range on the CatEx channel is significantly exceeded (very high concentration of flammable substances), a latching alarm is triggered. This CatEx latching alarm is acknowledged either automatically by a functioning (i.e. free of warnings and malfunctions) oxygen channel or by manually switching the unit off and on again in fresh air.

After the measuring range on the CatEx channel has been exceeded, the zero point and sensitivity (span) must be checked and adjusted if necessary before the instrument is used again. After the measuring range of the TOX measuring channels has been exceeded temporarily (up to one hour), checking the measuring channels is not necessary. When using a CatEx sensor in the Dräger X-am 2000, the zero point and sensitivity must be adjusted after any extreme impact loading.

Calling the Info Mode

- In measuring mode, press the  key for approx. 3 seconds.

Any information and fault codes, the peak values as well as the TWA¹⁾ and STEL^{*}) exposure values are displayed in succession (press the  key for the next display). If any warning or fault messages exist, the corresponding note or error codes are displayed (page 23 to page 27).



Warning messages are displayed. Numerical codes of the warning messages: see page 23.

↓
↓ -key



Fault messages are displayed. Numerical codes of the fault messages: see page 25.

↓
↓ -key



The peak values = the maximum measured values in the case of e.g. CO, H₂S, ... or the minimum measured values in the case of O₂ within the storage interval are displayed

↓
↓  key



The average values of the exposures based on a shift of e.g. 8 hours (TWA) of all the active sensors for the exposure evaluation are displayed

↓
↓  key



The short-term values (STEL) = average values of the concentrations over the average value duration of all the active sensors for the exposure evaluation are displayed

↓
↓  key

The device is in measuring mode again

— If no key is pressed for 10 seconds, the device returns automatically to measuring mode.

¹⁾ Only when activated in the device configuration. Delivery status: not activated.

Calling the Quick Menu

- If functions were activated for the quick menu with the PC software "CC Vision" (no functions are activated in the quick menu on delivery):
 - In measuring mode, press the \oplus key three times.
If no functions have been activated in the quick menu, the device remains in measuring mode.
- You can select the activated functions of the quick menu by pressing the \oplus key.
 - Press the OK key to call the selected function.

Possible functions of the quick menu

 Function test with gas (bump test), refer to page 29

 Fresh air calibration, refer to page 36

- Press the \oplus key to cancel the active function and to switch to measuring mode.
- If no key is pressed for 60 seconds, the device returns automatically to measuring mode.

Calling the Calibration Menu

- The calibration menu can only be accessed by entering a password.
Password on delivery: » 001 «
- The default password on delivery can be changed using the PC software "CC Vision".
- In measuring mode, press the **+** key for at least 5 seconds.
- The function for entering the password is selected.
- The special symbol » **🔒** « (for the "enter password" function) is displayed.
- The display shows » 000 « with the first digit flashing.
- Use the **+** key to set the flashing digit.
- Press the **OK** key, the second digit starts flashing.
- Use the **+** key to set the flashing digit.
- Press the **OK** key, the third digit starts flashing.
- Use the **+** key to set the flashing digit.
- Press the **OK** key to confirm the password once it has been set completely.
- The calibration menu functions can now be selected by pressing the **+** key.
- Press the **OK** key to call the selected function.

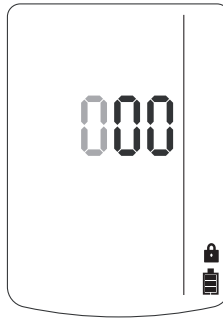



02323854_01.epa

Calibration menu functions

 Fresh air calibration, refer to page 36

 1-button calibration, refer to page 38

 Single gas calibration, refer to page 40

- Press the  key to cancel the active function.
- If no key is pressed for 10 minutes, the device returns automatically to measuring mode.

Identifying Alarms

An alarm is displayed visually, audibly and through vibration in a specific pattern.

Concentration pre-alarm A1

The alarm is indicated by an intermittent alarm message:



Display » **A1** « and measured value alternating: not for O₂!

— The pre-alarm A1 is not self-latching and stops when the concentration has dropped below the alarm setpoint A1.

— In the case of A1 a single tone is audible and the alarm LED flashes.

Acknowledging a pre-alarm:

- Press the  key. Only the audible alarm and the vibration alarm are switched off.

Concentration main alarm A2

The alarm is indicated by an intermittent alarm message:



Display » **A2** « and measured value alternating:

In the case of A2 a double tone is audible and the alarm LED flashes twice.



For O₂: » **A1** « and measurement value alternating = oxygen deficiency

» **A2** « and measurement value alternating = oxygen surplus

DANGER

Leave the area immediately. Danger to life! A main alarm is self-latching and cannot be acknowledged or cancelled.

After leaving the area, if the concentration is less than the alarm setpoint A2:

- Press the  key. The alarm messages are switched off.
- A latching alarm on the CatEx channel (due to the measuring range being significantly exceeded) cannot be acknowledged by the  key. The CatEx latching alarm is acknowledged either automatically by a functioning (i.e. free of warnings and malfunctions) oxygen channel or by manually switching the unit off and on again in fresh air.

STEL / TWA exposure alarm

The alarm is indicated by an intermittent alarm message:



Display » **A2** « and »  « or »  « and measured value alternating:

CAUTION

Leave the area immediately. After this alarm, the deployment of personnel is subject to the relevant national regulations.

— The STEL and TWA alarm cannot be acknowledged or cancelled.

- Switch off the device. The values for the exposure evaluation are deleted after the device is switched on again.

Battery pre-alarm

The alarm is indicated by an intermittent alarm message:



Flashing special symbol »  « on the right side of the display:

Acknowledging the pre-alarm:

- Press the  key. Only the audible alarm and the vibration alarm are switched off.
- The battery still lasts approx. 20 minutes after the first battery pre-alarm.

Battery main alarm

The alarm is indicated by an intermittent alarm message:



Flashing special symbol »  « on the right side of the display:

The battery main alarm cannot be acknowledged or cancelled:

- The device is automatically switched off again after 10 seconds.
- Before the device is switched off, the visual, audible and vibration alarms are activated for a short time.

Device alarm

Intermittent alarm message:



Special symbol »  « on the right side of the display:

- The device or one or several sensor channels are not ready for operation.
- For remedies, refer to page 23 to page 25.
- If necessary, commission the Dräger Safety Service Center to eliminate the error.

End of operation

Only in the case of X-am 1100 and X-am 1700.

A warning period starts before the end of the operating time.

- After switching on the device, the special symbol »  « (for warning) is displayed.

Acknowledging the end of operation warning:

- Press the  key. The device will continue to operate until the operating time has elapsed.
- When the operating time has elapsed, the text » **d 0** « flashes. The device cannot be switched on anymore.

Pump Operation

With Dräger X-am 125 pump

Accessories:

Dräger X-am 125 pump, sampling hose and probes, see Order List, see “Accessories” on page 53

Commissioning and performing the measurement:

- see the Instructions for Use of the Dräger X-am 125.

With hand pump adapter and rubber ball pump

Accessories:

Hand pump adapter, rubber ball pump, sampling hose and probes, see Order List, see “Accessories” on page 53.

Commissioning and performing the measurement:

- see the Instructions for Use of the used accessories.

Observe the following during pump operation mode

- The required waiting time when flushing the extension hose or probes.
Prior to every measurement, flush the Dräger sampling hose or the Dräger probes with the air sample to be measured.
- It is absolutely necessary to flush the extension hose for a period of time to eliminate or minimize the effects which may interfere with measurements when using a sampling hose or a probe, e.g. memory effects, dead volume.
- The flushing time depends on various factors e.g. type and concentration of the gas or vapor to be measured, material, length, diameter and age of the sampling hose or the probe. Generally, when using a sampling hose (new, dry, clean), a typical flushing time of approx. 3 seconds is required per meter. This flushing time applies in addition to the sensor response time (see the Instructions for Use of the used gas measuring device).
Example:
- In the case of a 10 m long sampling hose, the flushing time is approx. 30 seconds and the sensor response time is in addition approx. 60 seconds. Hence, the total time required to read the gas measuring device is approx. 90 seconds.
- The flow rate alarm is delayed depending on the length of the hose by 10 to 30 seconds.

Configuring the Device

To individually configure a device with standard configuration, the device must be connected with a PC.

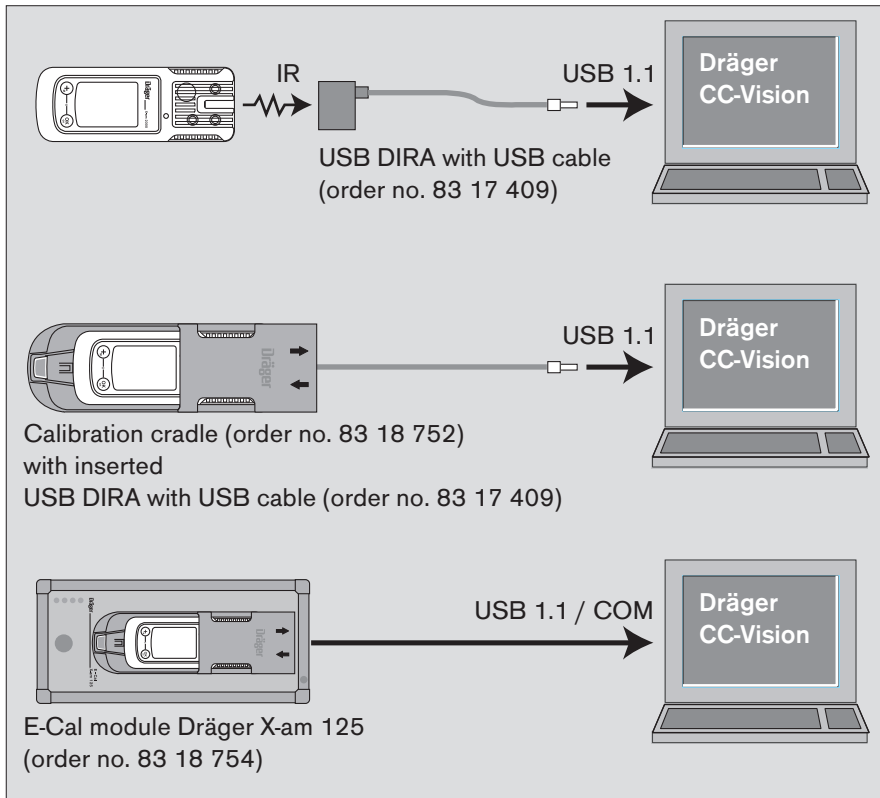

The installed PC software "CC Vision" is used for configuration.

- Observe the documentation and online help of the software.

— A version of Dräger CC Vision which can be used for X-am 1100/1700/2000 is supplied with the device on CD.

Read Data Base and Display Graphically

To read the data base of the device and display it graphically, the device must be connected with a PC.

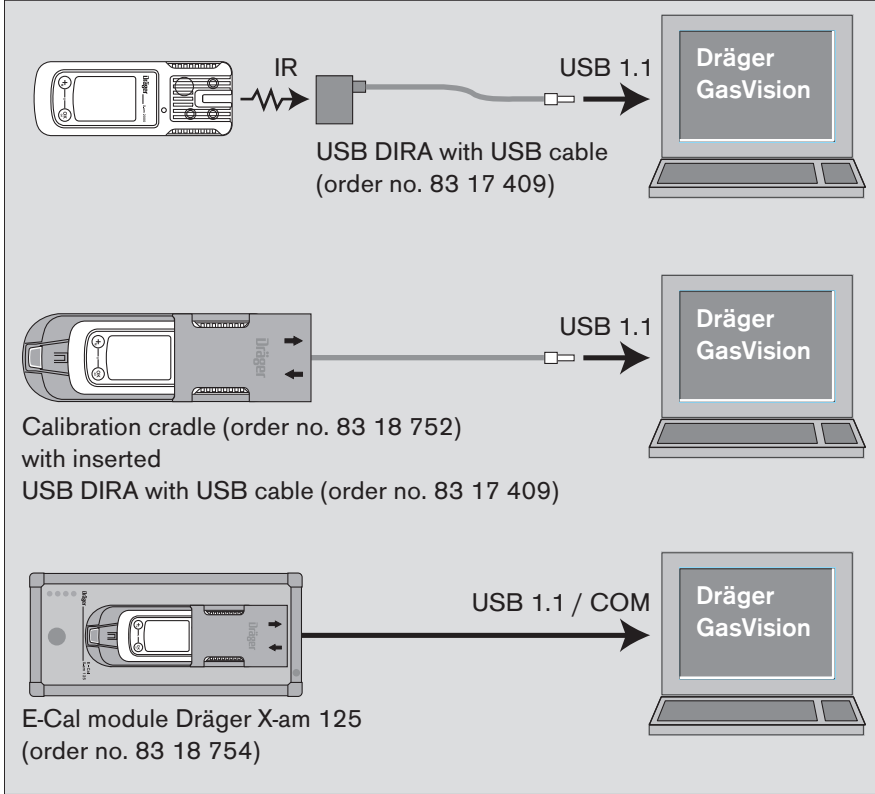

The installed PC software "GasVision" is used for reading and displaying the data base.

- Observe the documentation and online help of the software.

Faults, Cause and Remedy

Fault	Cause	Remedy
Not possible to switch on the device	Discharge the power pack	Charge the power pack, page 43.
	Discharge the alkaline batteries	Insert new alkaline batteries, page 42.
Not possible to switch off the device	The device is not set to measuring mode	Select measuring mode.
	The device is configured to "Disable prohibited"	Configure the device to "Disable allowed" with "CC Vision".
Display » --- «	Measuring range calibrated incorrectly	Recalibrate the measuring range, page 35.
	Electronics or sensors defective	Must be repaired by Dräger-Service.

To display the numerical codes of the warning and fault messages in the info mode, see page 14.

Warning messages

Special symbol » ⓘ « and displayed numerical code:	Cause	Remedy
151	Service life of device about to elapse	Procure follow-on device.
152	Customer's service life counter about to elapse	Reset the service life counter using "CC Vision".
153	Data base 90% full	Read the data base soon and clear memory afterwards.
154	Data base full	Read the data base and clear memory.
155	Interval for the function test with gas (bump test) elapsed	Carry out the function test, page 29.
159	Calibration not possible. The menu function cannot be carried out because of a message which is preventing the function (e.g. sensors in warm-up phase).	Determine the message code via the info menu and switch it off, if necessary.
251	DrägerSensor CatEx 125 PR in warm-up phase	Wait until warm-up time is complete.
252	DrägerSensor CatEx 125 PR in warm-up phase	Wait until warm-up time is complete.

Special symbol » ⓘ « and displayed numerical code:	Cause	Remedy
253	Ex concentration has drifted into the negative range	Carry out the fresh air calibration, page 36.
254	The temperature is too high	Operate the device within the allowed temperature range.
255	The temperature is too low	Operate the device within the allowed temperature range.
256	The calibration interval for DrägerSensor CatEx 125 PR has elapsed	Carry out the span calibration for DrägerSensor CatEx 125 PR, page 40.
257	Alarm setpoint A2 setting is greater than 60 %LEL	Set alarm setpoint to less than 60 % LEL.
351	DrägerSensor XXS O ₂ in the warm-up phase	Wait until warm-up time is complete.
352	DrägerSensor XXS O ₂ in the warm-up phase	Wait until warm-up time is complete.
353	O ₂ concentration drifted into the negative range	Fresh air calibration required, page 36.
354	The temperature is too high	Operate the device within the allowed temperature range.
355	The temperature is too low	Operate the device within the allowed temperature range.
356	The calibration interval for DrägerSensor XXS O ₂ has elapsed	Carry out the span calibration for DrägerSensor XXS O ₂ , page 40.
451	DrägerSensor XXS H ₂ S in the warm-up phase	Wait until warm-up time is complete.
452	DrägerSensor XXS H ₂ S in the warm-up phase	Wait until warm-up time is complete.
453	H ₂ S concentration has drifted into the negative range	Carry out the fresh air calibration, page 36.
454	The temperature is too high	Operate the device within the allowed temperature range.
455	The temperature is too low	Operate the device within the allowed temperature range.
456	The calibration interval for DrägerSensor XXS H ₂ S has elapsed	Carry out the span calibration for DrägerSensor XXS H ₂ S, page 40.
551	DrägerSensor XXS CO in the warm-up phase	Wait until warm-up time is complete.

Special symbol » ☐ « and displayed numerical code:	Cause	Remedy
552	DrägerSensor XXS CO in the warm-up phase	Wait until warm-up time is complete.
553	CO concentration has drifted into the negative range	Carry out the fresh air calibration, page 36.
554	The temperature is too high	Operate the device within the allowed temperature range.
555	The temperature is too low	Operate the device within the allowed temperature range.
556	The calibration interval for DrägerSensor XXS CO has elapsed	Carry out the span calibration for DrägerSensor XXS CO, page 40.

Fault messages

Special symbol » ☒ « and displayed numerical code:	Cause	Remedy
101	The service life of the device has elapsed	Return the device to Dräger Safety to be disposed.
102	The customer's service life counter has elapsed	Reset the service life counter using "CC Vision".
103	The device is defective	The device must be repaired by DrägerService.
104	Check sum error program code	The device must be repaired by DrägerService.
105	Update error	The device must be repaired by DrägerService.
106	Check sum error data	Reconfigure the device with "CC Vision", otherwise return device to DrägerService.
107	The device is defective	The device must be repaired by DrägerService.
108	The data base is defective	Execute the menu function again; otherwise the device must be repaired by DrägerService.
109	The menu function cannot be carried out because of an error.	Determine the error code via the info menu and switch it off, if necessary.
201	The zero point calibration of the DrägerSensor CatEx 125 PR is not valid	Carry out the fresh air calibration, page 36.

Special symbol » ☒ « and displayed numerical code:	Cause	Remedy
202	The span calibration of the DrägerSensor CatEx 125 PR is not valid	Carry out the span calibration, page 38 or page 40.
203	The measurement value of the DrägerSensor CatEx 125 PR is in the negative range	Carry out the fresh air calibration, page 36.
204	The DrägerSensor CatEx 125 PR is not inserted	Check the DrägerSensor CatEx 125 PR, page 46.
205	Error during the function test with gas (bump test) of the DrägerSensor CatEx 125 PR	Repeat the function test, calibrate or replace the DrägerSensor CatEx 125 PR, if necessary, page 46.
206	Function not possible: O ₂ deficiency	Use DrägerSensor CatEx 125 PR in atmospheres with more than 10.0 % O ₂ by vol..
301	The zero point calibration of DrägerSensor XXS O ₂ is not valid	Carry out the fresh air calibration, page 36.
302	The span calibration of the DrägerSensor XXS O ₂ is not valid	Carry out the span calibration, page 40 or carry out the fresh air calibration, page 36.
303	O ₂ concentration drifted into the negative range	Fresh air calibration required, page 36.
304	The DrägerSensor XXS O ₂ is not inserted	Check the DrägerSensor XXS O ₂ , page 46.
305	Error during the function test with gas (bump test) of the DrägerSensor XXS O ₂	Repeat the function test, calibrate or replace the DrägerSensor XXS O ₂ if necessary, page 46.

401	The zero point calibration of DrägerSensor XXS H ₂ S is not valid	Carry out the fresh air calibration, page 36.
402	The span calibration of the DrägerSensor XXS H ₂ S is not valid	Carry out the span calibration, page 40.
403	Measured value of the DrägerSensor XXS H ₂ S is in the negative range	Carry out the fresh air calibration, page 36.
404	DrägerSensor XXS H ₂ S is not inserted	Check DrägerSensor XXS H ₂ S, page 46.

Special symbol » ☒ « and displayed numerical code:	Cause	Remedy
405	Error during the function test with gas (bump test) of the DrägerSensor XXS H ₂ S	Repeat the function test, calibrate or replace the DrägerSensor XXS H ₂ S, if necessary, page 46.
501	The zero point calibration of the DrägerSensor XXS CO is not valid	Carry out the fresh air calibration, page 36.
502	The span calibration of the DrägerSensor XXS CO is not valid	Carry out the span calibration, page 40.
503	The measured value of the DrägerSensor XXS CO is in the negative range	Carry out the fresh air calibration, page 36.
504	The DrägerSensor XXS CO is not inserted	Check the DrägerSensor XXS CO, page 46.
505	Error during the function test with gas (bump test) of the DrägerSensor XXS CO	Repeat the function test, calibrate or replace the DrägerSensor XXS CO, if necessary, page 46.

Maintenance

Maintenance intervals

The device should be inspected and maintained by suitably qualified persons every six months (consult: EN 60079-29-2 – Gas measuring device - Selection, installation, use and maintenance of apparatus for the measurement of combustible gases or oxygen, EN 45544-4 – Electrical apparatus used for the direct detection and direct concentration measurement of toxic gases and vapours - Part 4: Guide for selection, installation, use and maintenance and national regulations). We recommend that you calibrate all channels after 6 months.

- Depending on device configuration:
Replace the alkaline batteries or charge the battery – refer to page 42 to page 43 – after each use, at the latest after the battery alarm has been triggered or after 2 weeks.

- Device calibration – page 35.
 - In regular intervals, according to the used sensors and the operating conditions. For sensor-specific calibration data, refer to the Instructions for Use of the used sensors¹⁾.
 - Before you carry out safety-related relevant measurements, the zero point and sensitivity of the devices should be tested in accordance with national regulations.

- Inspection by suitably qualified persons – every year.
 - The inspection intervals must be established in each individual case and shortened if necessary, depending on technical safety considerations, engineering conditions and the technical requirements of the equipment.
 - We recommend that a service agreement be concluded with Dräger Safety and that repairs also be carried out by them.

- Replace the sensors, page 46 – if necessary, when it is not possible to calibrate the sensors anymore.

¹⁾ The Instructions for Use of the used sensors are supplied with the device on CD.

Carrying Out the Function Test with Gas (Bump Test)

Manual implementation without the documentation of result in the device memory

- Prepare a test gas cylinder, the volume flow must be 0.5 L/min and the gas concentration must be higher than the alarm setpoint concentration to be tested.
Example test gas cylinder 68 11 130 = mixed gas with 50 ppm CO, 15 ppm H₂S, 2.5 vol. % CH₄, 18 vol. % O₂
- Connect the test gas cylinder with the calibration cradle (83 18 752).
- Vent the test gas into a fume cupboard or into the open air (with a hose connected to the second connector of the calibration cradle).

CAUTION

Do not inhale the test gas. Risk to health!
Observe the hazard warnings of the relevant Safety Data Sheets.

- Switch on the device and insert it into the calibration cradle – press downwards until it engages.
 - Open the test gas cylinder valve to let test gas flow over the sensors.
 - Wait until the device displays the test gas concentration with sufficient tolerance –
Ex: 40 %LEL ... 74 %LEL¹⁾
O₂: 17.4 vol.-% ... 18.6 vol.-%¹⁾
H₂S: 12 ppm ... 18 ppm¹⁾
CO: 40 ppm ... 60 ppm¹⁾
If the alarm setpoints are exceeded, the device displays the gas concentration in alternation with » **A1** « or » **A2** « depending on the test gas concentration.
 - Close the test gas cylinder valve and remove the device from the calibration cradle.
- If the concentration has now fallen under the A1 alarm setpoint:
- Acknowledge the alarm.
 - If the displays are outside of the above-mentioned ranges:
Calibrating the device, refer to page 35.

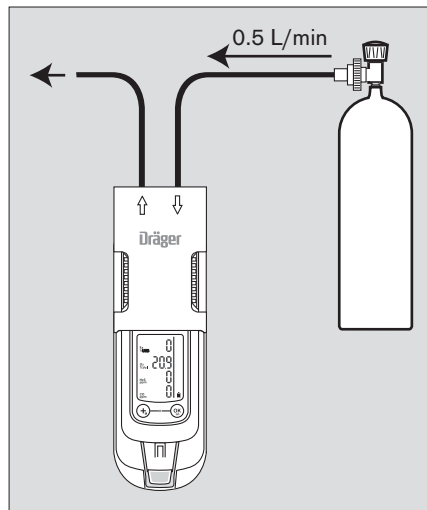

00523854_01_en.eps

1) Upon application of the Dräger mixed gas (order no. 68 11 130), the displays should be in this range. Different concentrations can be adjusted using the enclosed software Dräger CC Vision.

Menu implementation with the documentation of results in the device memory

The setting whether the bump test is to be carried out manually or automatically is made using the PC software Dräger CC Vision.

Setting on delivery: automatic bump test.

- Prepare a test gas cylinder, the volume flow must be 0.5 L/min and the gas concentration must be higher than the alarm setpoint concentration to be tested.
Example test gas cylinder 68 11 130 = mixed gas with 50 ppm CO, 15 ppm H₂S, 2.5 vol. % CH₄, 18 vol. % O₂
- Connect the test gas cylinder with the calibration cradle (83 18 752).
- Vent the test gas into a fume cupboard or into the open air (with a hose connected to the second connector of the calibration cradle).

⚠ CAUTION

Do not inhale the test gas. Risk to health!
Observe the hazard warnings of the relevant Safety Data Sheets.

- Switch on the device and insert it into the calibration cradle – press downwards until it engages.
- Call the quick menu and select the function test with gas (bump test), page 15.

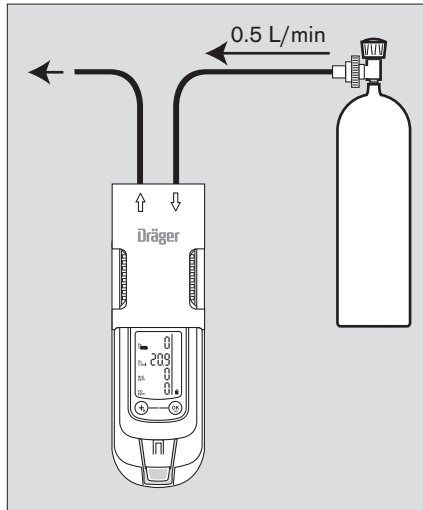

00523854_01_en.epa

- The current gas concentration values and the special symbol » √∩ « (for bump test) flash.
- Press the **OK** key to start the function test with gas.
- Open the test gas cylinder valve to let test gas flow over the sensor.
- If gas concentration exceeds the alarm thresholds A 1 or A 2 the corresponding alarm will occur.
Exit the function test with gas:

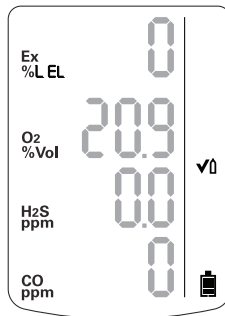

For the manual bump test:

After the set bump test concentration is reached:

- Press the **OK** key.
- The display containing the current gas concentration changes with the display » **OK** «.
- The bump test that was carried out is documented with the result and date in the device memory.
- Close the test gas cylinder valve and remove the device from the calibration cradle.
- If the concentration values have now fallen under the A1 alarm setpoints, the device returns to the measuring mode.
- If during the function test no alarm occurs within 1 minute and the gassing test was not confirmed by pressing OK, the alarm mode is activated to indicate failure.
- The fault message » **✘** « appears and » - - « is displayed instead of the measured value on the faulty measuring channel.
- In this case, repeat the function test with gas or calibrate the device, page 35.

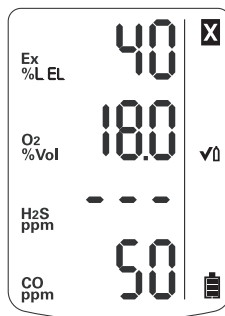
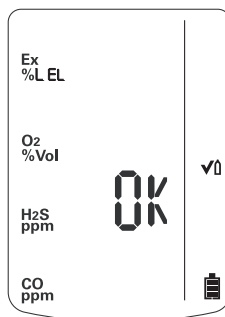

02523854_01_en.eps

02523854_01_en.eps

02523854_01_en.eps

For the automatic bump test:

After the set bump test concentration is reached:

- The display containing the current gas concentration changes with the display » **OK** «.
- The bump test that was carried out is documented with the result and date in the device memory.
- Close the test gas cylinder valve and remove the device from the calibration cradle.
- If the concentration values have now fallen under the A1 alarm setpoints, the device returns to the measuring mode.
- If during the function test no alarm occurs within 1 minute, the alarm mode is activated to indicate failure.
- The fault message »  « appears and » - - « is displayed instead of the measured value on the faulty measuring channel.
- In this case, repeat the function test with gas or calibrate the device, page 35.

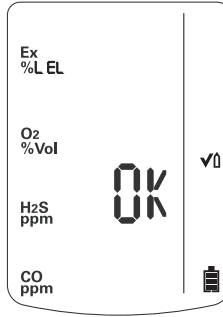

02623854_01_en.eps

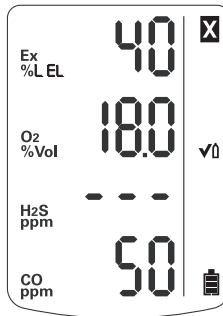

02623854_01_en.eps

The function test with gas can also be carried out automatically.

The "Bump Test Station" is required for this function, refer to page 33.

Automatic implementation with the Bump Test Station

Prerequisite:

The device must first be configured for the automatic function test with gas (bump test) using the PC software "CC Vision".

- Activate the device for the automatic function test.
- Composition of test gas (mixed gas) – standard on delivery: 50 ppm CO, 15 ppm H₂S, 2.5 vol. % CH₄, 18 vol. % O₂
- Define which measuring channels should participate in the automatic function test. By default, all measuring channels participate in the function test.

- Prepare the Bump Test Station according to the instructions.
- Switch on the device and insert it into the receptacle of the Bump Test Station until it locks into place.

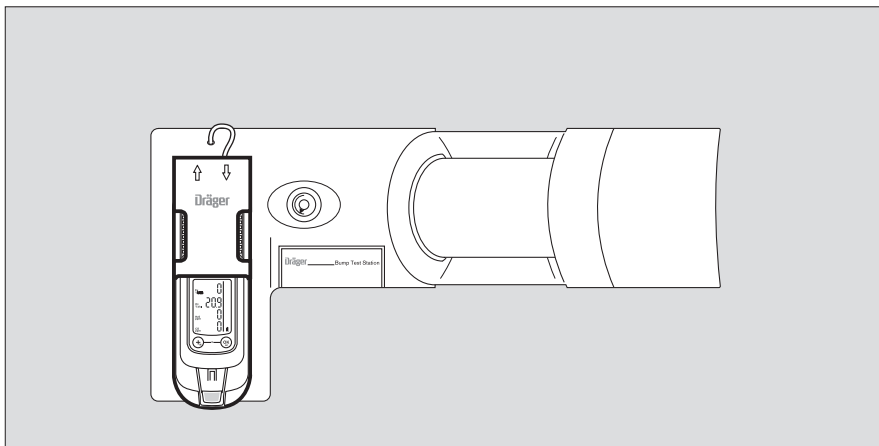

- The function test with gas is started automatically. The special symbol » \checkmark « (for bump test) flashes.
- If the gas concentration exceeds the alarm setpoint A 1 or A 2, the relevant alarm is triggered, which is automatically acknowledged after approx. 10 seconds. Next:
- The display of the current gas concentration changes with the display » **OK** «. The bump test that was carried out is documented with the result and date in the device memory.

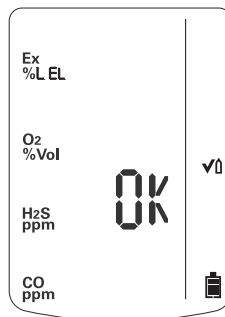

02523854_01_enr

02523854_01_enr

- Remove the device from the Bump Test Station.
- If the concentration values have now fallen under the A1 alarm setpoints, the device returns to the measuring mode.
- If during the function test no alarm occurs and the current measured values do not reach the set target concentration, the error alarm is activated to indicate failure.
- The fault message »  « appears and » - - « is displayed instead of the measured value on the faulty measuring channel.
- In this case, repeat the function test with gas or calibrate the device, page 35.

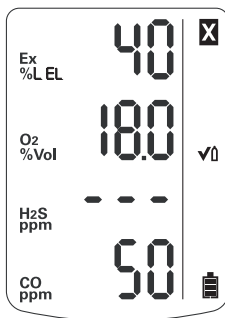

The function test with gas can also be carried out manually, refer to page 29 and page 30.

Calibrating / Adjusting the Device

Calibration may not be possible due to device and channel errors.

Allow the sensors to warm up before the calibration / adjustment!

Warm-up time: refer to the Instructions for Use of the installed DrägerSensors (on CD).

Calibration interval:

- Observe the relevant specifications in the Instructions for Use of the installed DrägerSensors.
- For critical applications, observe the recommendations in EN 60079-29-2¹⁾ or EN 45544-4²⁾ and national regulations. We recommend that you calibrate all channels after 6 months.

⚠ CAUTION
Do not inhale the test gas. Risk to health! Observe the hazard warnings of the relevant Safety Data Sheets.



- Improve the zero point accuracy – carry out the fresh air calibration, page 36.
- Set the sensitivity of all sensors to the value of the test gas – carry out the 1-button calibration, page 38.
- Set the sensor sensitivity to a value of the test gas – calibrate/adjust the sensitivity, page 40.

1) EN 60079-29-2 – Gas measuring device - Selection, installation, use and maintenance of apparatus for the measurement of combustible gases or oxygen.

2) EN 45544-4 – Electrical devices for the direct detection and direct concentration measurement of toxic gases and vapours – Part 4: Guidelines for selection, installation, use and maintenance.

Carrying out the fresh air calibration

To improve the zero point accuracy, you can carry out a fresh air calibration.

- Calibrate the device to fresh air, free of measured gases or other interfering gases.
- All the sensors are included in the fresh air calibration. Sensors which have not warmed up or which are faulty prevent a calibration.
In the case of sensors which are in the warm-up phase, the message » **159** « is displayed with the special symbol »  « (for warning message).
In the case of a sensor or device error, the message » 109 « is displayed with the special symbol »  « (for fault message).
The message is cleared after 5 seconds and the function is available again in the menu.
- During the fresh air calibration, the zero point of all the sensors (with the exception of the DrägerSensor XXS O₂) is set to 0.
In the case of the DrägerSensor XXS O₂, the display is set to 20.9 vol. %.
- Switch on the device.

Depending on device configuration:

- Call the quick menu and select the "fresh air calibration" function, page 15.
or
- Call the calibration menu and select the "fresh air calibration" function, page 16.
- The current gas concentration values flash.
When the measured values are stable:
- Press the  key to perform the fresh air calibration.

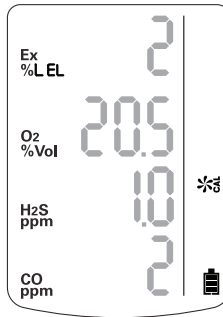

- The display containing the current gas concentration changes with the display » **OK** «.
- Press the  key to confirm the calibration or wait for 5 seconds.

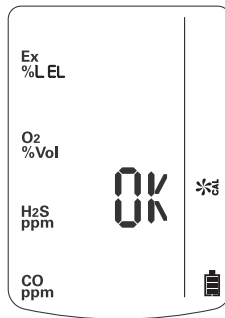

If a fault has occurred during the fresh air calibration.

- The fault message »  « appears and » - - « is displayed for the respective sensor instead of the measured value
- In this case, repeat the fresh air calibration.
- If necessary, replace the sensor, page 46.

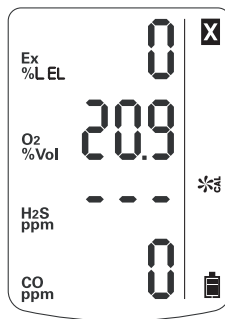

Carry out the 1-button calibration

- All the sensors which can be calibrated are included in the 1-button calibration. The sensors which have not warmed up or which are faulty are not included.
- In the case of the 1-button calibration, the sensitivity of all sensors is set to the value of the test gas.

When using the test gas cylinder

68 11 130 = mixed gas with 50 ppm CO, 15 ppm H₂S, 2.5 vol. % CH₄, 18 vol. % O₂.

- **If a mixed gas with another composition is used, the specified concentration values in the device must be changed to the target values of the used mixed gas using the PC software "Dräger CC Vision".**
- Connect the test gas cylinder with the calibration cradle.
- Vent the test gas leaving the adapter into a fume cupboard or into the open air (with a hose connected to the second connector of the calibration cradle).

⚠ CAUTION
Do not inhale the test gas. Risk to health! Observe the hazard warnings of the relevant Safety Data Sheets.

- Switch on the device and insert it into the calibration cradle until it locks into place.
- Call the calibration menu, enter the password and select the "1-button calibration" function, page 16.
- Press the **OK** key to start the 1-button calibration.
- Open the test gas cylinder valve to let test gas flow over the sensor.
 - The currently displayed measured values start to flash.
 - The flashing stops after a static measured value has been reached.
 - The calibration is now carried out automatically.
 - The displayed measured values change to the values according to the gas supplied.

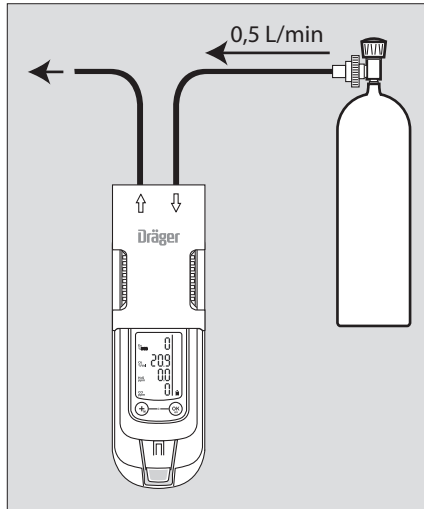

02723854_01.eps

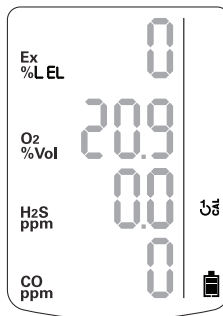

02823854_01_en.eps

When the calibration is completed and the displayed measured values are stable:

- The display containing the current gas concentration changes with the display » **OK** «.
- Press the **OK** key or wait for 5 minutes to quit the calibration.
- The device changes to the measuring mode

- Close the test gas cylinder valve and remove the device from the calibration cradle.

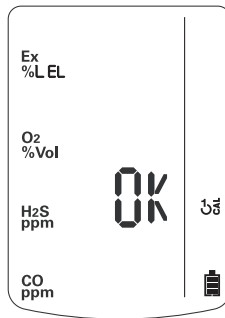

If a fault has occurred during the 1-button calibration.

- The fault message » **X** « appears and » - - « is displayed for the respective sensor instead of the measured value
- In this case, repeat the 1-button calibration or carry out a single gas calibration (Span cal), refer to page 40.
- If necessary, replace the sensor, page 46.

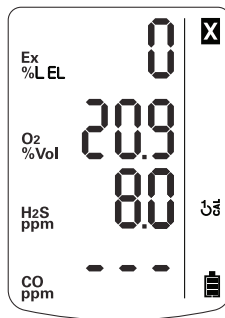

02523854_01_en.eps

03023854_01_en.eps

Calibrating/adjusting the sensitivity for a single measuring channel

- The span calibration can be carried out specifically for individual sensors.
- In the case of the span calibration, the sensitivity of the selected sensor is set to the value of the used test gas.
- Use a standard test gas.
Allowed test gas concentration:
Ex: 40 to 100 %LEL
O₂ 10 to 25 vol. %
CO: 20 to 999 ppm
H₂S: 5 to 99 ppm

- Connect the test gas cylinder with the calibration cradle.
- Vent the test gas leaving the adapter into a fume cupboard or into the open air (with a hose connected to the second connector of the calibration cradle).

CAUTION

Do not inhale the test gas. Risk to health!
Observe the hazard warnings of the relevant Safety Data Sheets.

- Switch on the device and insert it into the calibration cradle.
- **Press the [+] key** and keep it depressed for 5 seconds to call the calibration menu, enter the password and select the "span calibration" function, page 16.
- Press the **OK** key to start the span calibration.
- The display flashes the gas of the first measuring channel, e.g. » Ex - %LEL «.
- Press the **OK** key to carry out the calibration of this measuring channel.
or
- Use the **+** key to select another measuring channel (O₂ - vol. %, H₂S - ppm or CO - ppm).

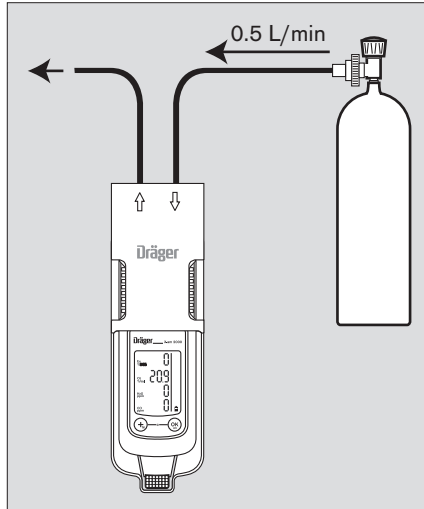

02723854_01_en.eps

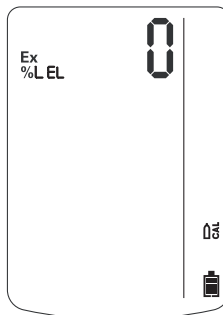

03523854_01_en.eps

- Press the **OK** key to carry out the calibration of the selected measuring channel.
- The calibration gas concentration is displayed.
- **Press the [OK] key** to confirm the calibration gas concentration or use the **[+]** key to change the calibration gas concentration and complete the process by pressing the **[OK] key**.
- The measurement value flashes.

- Open the test gas cylinder valve to let test gas flow over the sensor.
- The displayed, flashing measurement value changes to the value according to the supplied test gas.

When the displayed value has stabilized (after at least 120 seconds):

- Press the **OK** key.
- The display containing the current gas concentration changes with the display **» OK «**.
- Press the **OK** key to quit the calibration of this measuring channel.

- The next measuring channel is offered for calibration.
- After the last measuring channel has been calibrated/adjusted, the device switches to measuring mode.

- Close the test gas cylinder valve and remove the device from the calibration cradle.

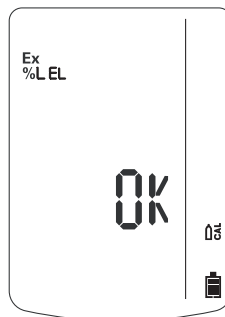

03623854_01_en.nps

If a fault has occurred during the span calibration.

- The fault message **» E «** appears and **» - - «** is displayed for the respective sensor instead of the measured value
- In this case, repeat the calibration.
- If necessary, replace the sensor, page 46.

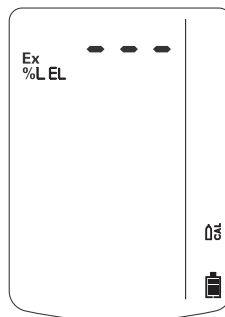

03723854_01_en.nps

Note on adjusting the Ex channel to nonane as the measured gas:

- When calibrating the Ex channel, propane can be used as a substitute for the calibration gas.
- When using propane to adjust the Ex channel to nonane, the display must be set to 2x the test gas concentration used.

Replacing the Batteries / Rechargeable Batteries

⚠ WARNING

Do not replace the batteries / rechargeable batteries in hazardous areas. Danger of explosion!

Batteries / rechargeable batteries are part of the Ex approval. Only the following types may be used:

Alkaline batteries – T4 – (not rechargeable!)

Energizer No. E91, Energizer No. EN91 (Industrial), Varta Type 4106 (power one),

Varta Type 4006 (Industrial)

NiMH rechargeable batteries – T3 – (rechargeable)

GP 180AAHC (1800) max. 40 °C ambient temperature.

Switching off the device:

- Keep the **OK** key and the **+** key depressed at the same time.
- 1 Loosen the screw (2.0 mm hexagon socket) on the power pack and remove the power pack.
 - 2 Replace the alkaline batteries with new ones or rechargeable NiMHy batteries with charged ones – **ensure correct polarity**.
 - 3 Completely replace the power pack T4 (with sealed rechargeable batteries, order no. 83 18 704).
- Insert the power pack into the device and tighten screw, the device is switched on automatically.

After replacing the power pack T4, it is recommended that a complete charging is carried out.

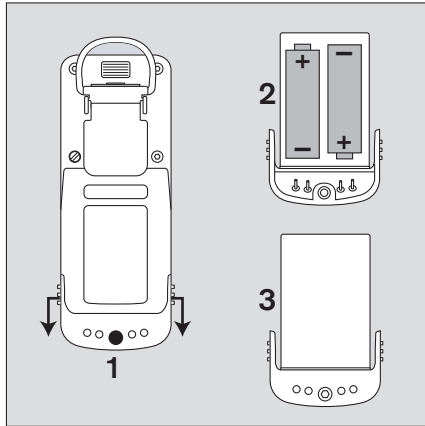

008238E4_01.rsp

⚠ WARNING

Do not throw used batteries into fire or try to open them by force. Danger of explosion!

Dispose of the batteries in accordance with local regulations.

After batteries have been replaced:

- The settings and data are stored when the battery is replaced.
The sensors warm up again.

Charging the Rechargeable Batteries

⚠ WARNING

Do not charge underground or in explosion-hazard areas! Danger of explosion!
The chargers are not designed in accordance with the regulations for firedamp and explosion protection.

Even if the device is not used, we recommend that you store the device in the charger (Charging module X-am 1/2/5000, order no. 83 18 639)!

To maintain the lifetime of the batteries, charging is temperature controlled and only performed in a temperature range of 5 to 35 °C.

When this temperature range is left, the charging is automatically interrupted and automatically continued after the temperature range has been reached again.

The charging time is typically 4 hours.

A new NiMH power pack reaches its full capacity after three full charging/discharging cycles.

Charging with the multiple charging station



- A maximum of 20 devices can be charged at the same time on the power pack (order no. 83 18 805) of the multiple charging station.
- When attaching the charging modules, disconnect the power pack from the mains supply!

Attaching charging modules

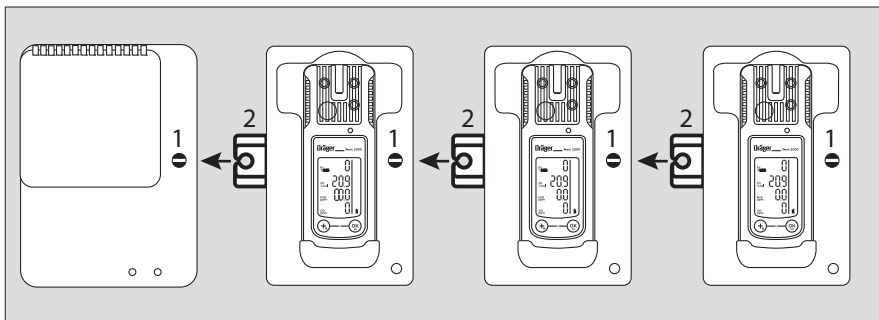
- 1 Turn the slots of the interlock into a horizontal position by using a screwdriver or coin.
- 2 Insert the projecting tongue of the charging module (at the same time, current entry) until it engages.
- 1 Close the interlock with a quarter turn (slot is positioned vertically).



- Attach additional charging modules in the same way.
- Always connect or disconnect the charging modules individually and not in groups in order to prevent the charging station from becoming damaged. During transportation, the power pack and the charging modules should also always be handled individually and without inserted devices.

- Position the device on an even and level surface.
 - Connecting the power pack to the mains.
- 1 The green "Mains" LED lights.
 - Insert the device into the charging module.
- 2 Display LED on the charger:
- | | |
|--|--------|
|  | Charge |
|  | Fault |
|  | Full |

If a fault occurs:

Remove the device from the charging module and insert it again.

If the fault still occurs, have the charging module repaired.

It takes approx. 4 hours to fully charge an empty rechargeable battery.

A short circuit of the charging contacts in the charging modules, e.g. by metallic objects that have fallen in, does not result in damage to the charging station. It should, however, be avoided due to possible heating hazards and incorrect displays on the charging module.

In the event of a short circuit or if the power pack is overloaded:

- 3 The red "Overload" LED lights, and an audible alarm sounds.
- After the fault has been corrected, the alarm is switched off automatically and the charging process is restarted.
 - In the event of a power failure, the devices already charged will be protected from discharging.

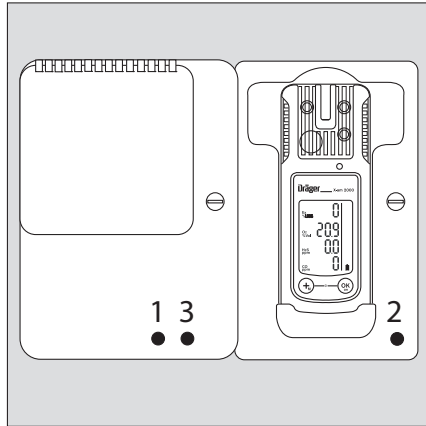

Charging with charging module and plug-in power pack or vehicle charging adapter

- When using the power pack (order no. 83 16 994), up to 5 devices can be charged at the same time, with power pack (order no. 83 15 635) up to 2 devices.
- The power pack contained in the rechargeable battery and charging kit (order no. 83 18 785) is suitable for charging a device.
- When using the vehicle charging adapter (order no. 83 17 754), it is recommended that you supply every charging module separately.

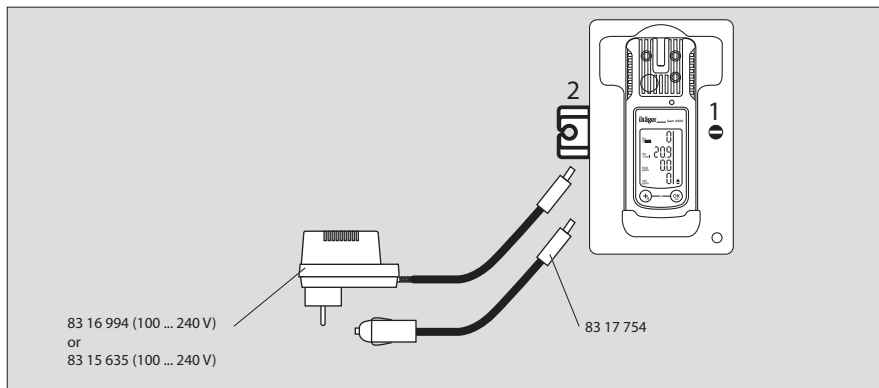

The charging process is carried out analogue to the charging with the multiple charging station.

Replacing the Sensors

- Switch off the device: keep the key **OK** and the **+** key depressed at the same time.
- Loosen the screw (2.0 mm hexagon socket) on the power pack and remove the power pack.
- Loosen the 4 screws (1.5 mm hexagon socket) on the rear panel of the device.
- Remove the upper half of the housing.

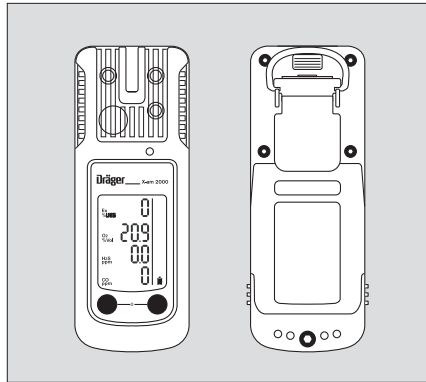

01123854_01.eps

Position of the sensors:

- 1 DrägerSensor CatEx 125 PR – 68 12 950
- 2 DrägerSensor XXS O₂ – 68 10 881 (blue marking)
- 3 DrägerSensor XXS H₂S LC – 68 11 525 (yellow marking)
- 4 DrägerSensor XXS CO – 68 10 882 (gray marking)

CAUTION

The position of the sensors must not be swapped! If the position is swapped, it can result in damage to the sensors.

- Remove the sensor to be replaced from the sensor receptacle – in the case of the DrägerSensor CatEx 125 PR, disconnect the flat cable connection before.
- Insert the new sensor into the sensor receptacle.
- Insert the flat cable connection of the DrägerSensor CatEx 125 PR into the plug-in connector on the board.
- Check that the sensors are positioned correctly and make adjustments if necessary.
- Attach the upper half of the housing and tighten the 4 screws on the rear panel.
- Insert the power pack into the device and tighten the screw.
- Switch on the device – Allow the sensors to warm up completely (max. 15 minutes).

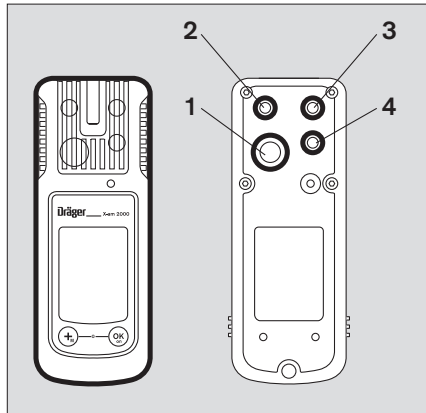

011923854_01.eps

Next:

- Carry out the fresh air calibration, page 36.
- and then:
- Calibrate the sensitivity:
 - either
 - carry out the 1-button calibration, page 38
 - or
 - calibrate/adjust the sensitivity, page 40.

Electrochemical sensors

- Do not expose to fire,
 - Do not force open. Danger! Acid-Burn Risk!
 - Like batteries, only dispose of as special waste,
- in accordance with local waste disposal regulations. Further information can be obtained from the relevant local authority and from appropriate waste disposal companies.

The DrägerSensor CatEx 125 PR should be disposed of as electronic waste.

Care

The device does not need any special maintenance.

- Dirt and deposits can be removed from the device by washing it with cold water. A sponge can be used for wiping if necessary.

<i>NOTICE</i>

Abrasive cleaning implements (brushes etc.), cleaning agents and cleaning solvents can destroy the dust and water filters.
--

- Carefully dab dry the device using a cloth.

Disposing of the Device



EU-wide regulations for the disposal of electric and electronic appliances which have been defined in the EU Directive 2002/96/EC and in national laws are effective from August 2005 and apply to this device.

Common household appliances can be disposed of using special collecting and recycling facilities. However, as this device has not been registered for household usage, it must not be disposed of through these means. The device can be returned to your national Dräger Sales Organization for disposal. Please do not hesitate to contact the above if you have any further questions on this issue.

Technical Data

Ambient conditions:	
during operation and storage	-20 to 50 °C or -20 to 40 °C (-20 to 40 °C for NiMH single cells type 180AAHC) 700 to 1300 hPa 10 to 90% (short-term up to 95%) relative humidity
Device data	
Protection class	IP 67 for devices with sensors
Intensity of alarm	Typically 90 dB (A) in 30 cm distance
Operation time	
– Alkaline battery	Typically 12 hours under normal conditions
– NiMHy rechargeable batteries	Typically 12 hours under normal conditions
Dimensions	approx. 130 mm x 48 mm x 44 mm (H x W x D)
Weight	approx. 220 g to 250 g
CE markings	Electromagnetic compatibility (Directive 89/336/EEC) Low Voltage Directive (Directive 72/23/EEC) Explosion protection (Directive 94/9/EEC)
Approvals:	see “Tests and Approvals” on page 6

Sensor Data

Extract! See the Instructions for Use of the used sensors for details.

	Ex	O ₂	H ₂ S LC	CO
Measuring principle	Catalytic combustion	Electro-chemical	Electro-chemical	Electro-chemical
Measured value response time $t_{0...90}$ for methane for propane	≤20 seconds ≤35 seconds	≤10 seconds	≤15 seconds	≤25 seconds
Measured value response time $t_{0...50}$ for methane for nonane	≤7 seconds ≤50 seconds ¹⁾	≤6 seconds	≤6 seconds	≤6 seconds

1) For falling concentrations, the settling time for nonane is 50 seconds.

	Ex	O ₂	H ₂ S LC	CO
Measuring range for methane	0 to 100 %LEL ¹⁾ 0 to 100 vol. %	0 to 25 vol. %	0 to 100 ppm H ₂ S	0 to 2000 ppm CO ²⁾
Zero error (EN 45544)	---	---	2 ppm	6 ppm
Device drift	---	---	≤1 % of the measured value/month	≤1 % of the measured value/month
Warm-up time	35 seconds	≤5 minutes	≤5 minutes	≤5 minutes
Effect of sensor poisons Hydrogen sulfide H ₂ S, 10 ppm	≤1 %LEL/ 8 hours	---	---	---
Halogenated hydrocarbons, heavy metals, gases containing silicone, sulfur or polymerizable substances	Poisoning possible	---	---	---
Measuring accuracy [% of the measured value]	≤5	≤1	≤2	≤2
Standards (Measuring function for explosion protection and measurement of oxygen deficiency and surplus as well as toxic gases, EXAM, Essen, Germany: BVS 08 ATEX G 002 ¹⁾ , PFG 08 G 001	EN 60079-29-1 ³⁾ EN 50271	EN 50104 (Measurement of oxygen deficiency and oxygen surplus) EN 50271	Type approval test applied for ⁴⁾	EN 45544-1/-2 ⁵⁾ EN 50271
Cross Sensitivities ⁶⁾	exist	exist	exist	exist

- 1) Alkanes from methane to nonane, LEL values according to EN 60079-20-1. When adjusting to propane, the deviation of the indication in air in the range 80 to 120 kPa can be up to 6 %LEL.
- 2) Certified for 3 to 500 ppm
- 3) The device responds to most combustible gases and vapors. The sensitivities differ depending on the type of gas. We recommend a calibration using the target gas to be measured. For the range of alkanes, the sensitivity decreases from methane to nonane.
- 4) The measuring signals can be affected additively by sulfur dioxide and nitrogen dioxide and negatively by chlorine.
- 5) The measuring signals can be affected additively by acetylene, hydrogen and nitrate monoxide.
- 6) A table of the cross sensitivities is contained in the Instructions for Use or the data sheet of the respective sensor.

Order List

Name and Description	Order no.
<p>Dräger X-am 1100 The maintenance-free 120 day 4-gas measuring device is equipped with an alkaline power pack and an O₂, Ex, CO and H₂S sensor.</p>	83 18 710
<p>Dräger X-am 1700 The device has a service life of 2 years and is equipped with an alkaline power pack and an O₂, Ex, CO and H₂S sensor.</p>	83 18 730
<p>Dräger X-am 2000 Standard device: Dräger X-am 2000 Ex, alkali Dräger X-am 2000 Ex, O₂, alkali Dräger X-am 2000 Ex, H₂S, alkali Dräger X-am 2000 Ex, CO, alkali Dräger X-am 2000 Ex, O₂, CO, alkali Dräger X-am 2000 Ex, O₂, H₂S, alkali Dräger X-am 2000 Ex, O₂, CO, H₂S, alkali Dräger X-am 2000 CO, H₂S, alkali Dräger X-am 2000 O₂, CO, alkali Dräger X-am 2000 O₂, H₂S, alkali Dräger X-am 2000 O₂, H₂S, CO, alkali</p>	83 18 750 83 18 770 83 18 780 83 18 790 83 18 880 83 18 890 83 18 910 83 18 696 83 18 697 83 18 698 83 18 699
<p>Basic device with a choice of special configurations, including a calibration certificate: Dräger X-am 2000 Ex, alkali Dräger X-am 2000 Ex, O₂, alkali Dräger X-am 2000 Ex, H₂S, alkali Dräger X-am 2000 Ex, CO, alkali Dräger X-am 2000 Ex, O₂, CO, alkali Dräger X-am 2000 Ex, O₂, H₂S, alkali Dräger X-am 2000 Ex, O₂, CO, H₂S, alkali</p>	83 18 751 83 18 771 83 18 781 83 18 791 83 18 881 83 18 891 83 18 911

Name and Description	Order no.
Power supply units:	
NiMH power pack T4	83 18 704
Alkaline power pack T3/T4 (without alkaline batteries) ¹⁾	83 18 703
Alkaline batteries T4 (2 pcs.) for alkaline power pack	83 18 708
T3 NiMH storage battery cell	83 19 426
Rechargeable battery and charging kit (contains NiMH power pack T4, charging module for Dräger X-am 1/2/5000 and plug-in power adapter)	83 18 785
Chargers:	
Charging module for Dräger X-am 1/2/5000	83 18 639
Power pack with connecting cord (worldwide) for several charging modules Dräger X-am 1/2/5000 (max. 20)	83 15 805
Plug-in power adapter (worldwide) for a maximum of 5 charging modules Dräger X-am 1/2/5000	83 16 994
Plug-in power pack (worldwide) for several charging module Dräger X-am 1/2/5000 (max. 2)	83 15 635
Vehicle connecting line 12V/24V for Dräger X-am 1/2/5000 charging module	83 17 754
Vehicle installation set for 1 Dräger X-am 1/2/5000 charging module	83 18 779
Accessories	
The accessories are not part of BVS 06 ATEX G 006 X and PFG 06 G 001.	
Pump accessories:	
Dräger X-am 125 pump	83 19 400
Carrying case for the Dräger X-am 125 pump	83 19 385
Manual pump	68 01 933
Adapter for manual pump	83 19 195
Dust and water filter	83 13 648
Extension hoses and probes:	
Measuring probe 0.5 m	64 08 238
Measuring probe 1.5m	64 08 239
Plug-in telescopic probe	68 01 954
Telescopic probe 100 with accessories	83 16 530
Telescopic probe 150 stainless steel	83 16 533

1) The alkaline power pack T3/T4 (order no. 83 18 703) is not part of the certification BVS 06 ATEX G 006 X and PFG 06 G 001.

Name and Description	Order no.
Tester 90	83 16 532
Float probe with accessories	83 18 371
Viton hose	12 03 150
Hose (not suitable for H ₂ S)	11 80 681
Accessories for measured value acquisition and configuration:	
GasVision	83 14 034
CC Vision	64 08 815
PC communication set 1 Dräger X-am 1/2/5000 with USB connection and CC Vision	83 18 761
PC communication set 2 X-am Dräger X-am 1/2/5000 with USB connection, CC Vision and barcode scanner	83 18 762
USB DIRA with USB cable (USB infrared adapter for communication Dräger X-am 1/2/5000 – PC)	83 17 409
Calibration accessories:	
Bump Test Station , including mixed gas cylinder	83 19 130
Dräger Mobile Printer, for the Bumptest Station	83 19 310
E-Cal module Dräger X-am 1/2/5000	83 18 754
Calibration cradle Dräger X-am 1/2/5000	83 18 752
Mixed gas cylinder 2.5 vol. % CH ₄ , 18 vol. % O ₂ , 15 ppm H ₂ S, 50 ppm CO	68 11 130
Test gas cylinder propane, 0,9 % by vol. C ₃ H ₈ in air	68 11 118
On demand controller	83 16 556
Standard controller	68 10 397
Other accessories:	
Carrying case	83 18 755
Support CD	83 18 705
Spare parts	
DrägerSensor CatEx 125 PR, 0 to 100 %LEL	68 12 950
DrägerSensor XXS O ₂ , 0 to 25 vol. % ¹⁾	68 10 881
DrägerSensor XXS CO, 0 to 2000 ppm ¹⁾	68 10 882
DrägerSensor XXS H ₂ S LC, 0 to 100 ppm ¹⁾	68 11 525

1) Expected service life of the sensors: O₂, CO and H₂S >2 years, CatEx > 3 years.

Declaration of Conformity

Drägersafety

Konformitätserklärung Declaration of Conformity

Wir / We Dräger Safety AG & Co. KGaA
Revalstraße 1
D-23560 Lübeck
Deutschland / Germany

erklären, dass das Produkt / declare that the product

Gasmessgerät Typ **LQG 00xx (X-am 1100, X-am 1700, X-am 2000)**
Gas Detection Instrument type **LQG 00xx (X-am 1100, X-am 1700, X-am 2000)**

gemäß den Bestimmungen der Richtlinie 94/9/EG (Geräte und Schutzsysteme zur bestimmungsgemäßen Verwendung in explosionsgefährdeten Bereichen) übereinstimmt mit dem Baumuster der EG-Baumusterprüfbescheinigung

following the provisions of Directive 94/9/EC (Equipment and protective systems intended for use in potentially explosive atmospheres) is in conformity with the type of the EC-type-examination certificates

DEMKO 06 ATEX 140055X

BVS 06 ATEX G 006X

für / for Gerätegruppe und -kategorie / Equipment Group and Category: **I M2 / II 2G**
Zündschutzart / Type of Protection: **ia d**
Explosionsgruppe / Explosion Group: **I / IIC**
Temperaturklasse / Temperature Class: **T4/T3**
und / and
die Messung brennbarer Gase & Dämpfe gemäß BVS 06 ATEX G 006X /
measurement of combustible, gases & vapours per BVS 06 ATEX G 006X.

ausgestellt von den benannten Stellen / issued by the notified bodies

UL International DEMKO A/S
Lyskær 8
DK-2730 Herlev
Kennn-Nr. / ident. no. 0539

EXAM – BGG Prüf- und Zertifizier GmbH
Dinnendahlstraße 9
D-44809 Bochum
Kennn-Nr. / ident. no. 0158.

Das Produkt wurde unter einem Qualitätssicherungssystem hergestellt, endabgenommen und geprüft, das zugelassen wurde von der benannten Stelle

The product has been manufactured, finally inspected and tested under a quality system which has been approved by the notified body

EXAM BGG Prüf- und Zertifizier GmbH
Dinnendahlstraße 9
D-44809 Bochum
Kennn-Nr. / ident. No. 0158.



Ralf Drews
Research & Development
Dräger Safety AG & Co. KGaA

Lübeck, 06.12.2006

Dokument-Nr. / document no.: SE20460 "01"
Seite 1 von 1 / page 1 of 1

Index

1-button calibration (1-button cal)	17, 38
Accessories	4, 53
Activating the Device	11
Activation sequence	11
Akkus laden	43
Alarm A1	10
Alarm A2	10
Ambient Conditions	50
Approvals	6
Areas subject to explosion hazards	4
Average values of exposures	14
Battery main alarm	19
Battery pre-alarm	19
Bump test	13, 15, 29
Bump Test Station	33
Calibrating / adjusting	35
Calibration accessories	54
Calibration cradle	29, 30
Calibration interval	35
Calibration menu functions	17
Calling the Calibration Menu	16
Calling the Info Mode	14
Calling the Quick Menu	15
Care	48
Catalyst poisons	13
CE marking	50
Chargers	53
Charging module	43
Charging the Rechargeable Batteries	43
Concentration main alarm A2	18
Concentration pre-alarm A1	18
Configuration	10
Configuration accessories	54
Configuring the Device	21
Coupling with electrical devices	4
Cross sensitivities	51
Declaration of Conformity	55
Device alarm	19

Device data	50
Dimensions	50
Display	8
Display data base graphically	22
Disposal	49
DrägerSensor CatEx 125 PR	46
DrägerSensor XXS CO	46
DrägerSensor XXS H2S	46
DrägerSensor XXS O2	46
Effect of sensor poisons	51
Electrochemical sensors	47
End of operation	19
Event documentation	29, 30
Extension hoses and probes	53
Fault	13, 23
Fault messages	25
Fresh air calibration (Fresh air cal)	15, 17, 36
Front panel	8
Function test with gas	13, 15, 29
Hazardous areas classified by divisions	7
Hazardous areas classified by zones	7
High concentration	13
Identifying Alarms	18
Inspection	28
Intended Operating Area	7
Intended Use	5
Intensity of alarm	50
LEL factor	10
Liability	4
Maintenance	4, 28
Maintenance intervals	28
Marking	6
Measured value acquisition accessories	54
Measuring accuracy	51
Measuring range	10
Mixed gas	29, 30
Multiple charging station	43
Negative drift	13
NiMHy-Akkus	42

Operating Conditions	7
Operation	12
Operation time	50
Order List	52
Oxygen-enriched atmosphere	13
Oxygen-poor atmosphere	13
Password	16
Password on delivery	16
PC software "CC Vision"	21
PC software "Gas Vision"	22
Peak values	14
Plug-in power pack	45
Position of the sensors	46
Power pack T4	42
Power supply units	53
Protection class	50
Pump accessories	53
Quick menu functions	15
Read data base	22
Rear panel	8
Remaining operating time	11
Replacing the Batteries	42
Replacing the Rechargeable Batteries	42
Replacing the Sensors	46
Safety	4
Safety Instructions	7
Safety-relevant measurements	13
Self test	12
Sensitivity for a gas (Span cal)	40
Sensor data	50
Service life	5
Short-term values	14
Single gas calibration (Span cal)	17
Software version	12
Span calibration	40
Spare parts	54
Special Symbols	9
Standard device configuration	10
Standard gas configuration	10
STEL	14
STEL / TWA exposure alarm	18

Switching off the device	12
Switching on the device	12
Technical Data	50
Tests	6
TWA	14
Vehicle charging adapter	45
Warm-up time of the sensors	12
Warning	13
Warning messages	23
What is What	8
Zero point accuracy	36

Dräger Safety AG & Co. KGaA

Revalstraße 1

D-23560 Lübeck

Germany

Tel. +49 451 8 82- 0

Fax +49 451 8 82- 20 80

www.draeger.com

90 23 854 - TH 4638.200 en

© Dräger Safety AG & Co. KGaA

Edition 06 - February 2011

(Edition 01 - February 2006)

Subject to alteration